

NTM SenseH₂® Hydrogen Sensor Key Technical Specifications

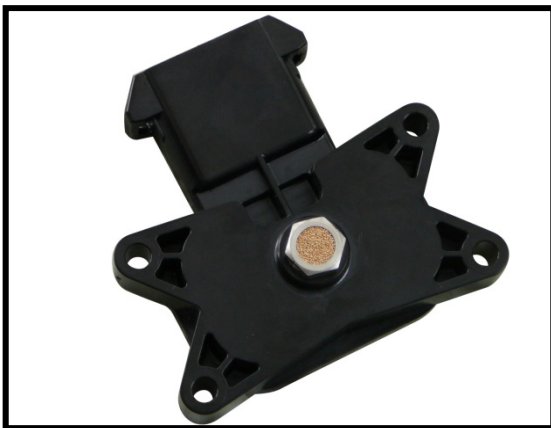

Features

- High sensitivity and selectivity to hydrogen
- Fast response and recovery times
- Immune to signal saturation
- Robust to widely varying ambient flow rates
- Compact and rugged design
- 1.0 to 4.5V output, spans 0.25 to 4.0% H₂ in air (5 to 100% LFL)
- UL Classified, ATEX, CE for hazardous locations

➤ Overview

Designed for hydrogen monitoring, this ceramic sensor exhibits a highly sensitive, selective, and rapid response to the presence of hydrogen in ambient air. It reliably measures H₂ concentrations over a wide range of temperature and humidity variation and provides a repeatable response, even in the presence of other combustible gases. Additionally, the NTM SenseH₂® hydrogen sensor is immune to signal saturation upon continuous exposure to low levels of hydrogen, and recovers rapidly and completely upon hydrogen removal.

➤ System Components

Sensor: The sensor element employs a patent-pending, chemi-resistive ceramic technology, which provides accurate and reliable hydrogen detection.

Electronics package: The sensor provides a simple interface with a ratio-metric voltage output (1 to 4.5 VDC; 500mV increments), calibrated to detect up to 4% H₂ in air (100% of the LFL). Diagnostic states (< 1V, >4.5V) are provided to indicate error conditions. Microprocessor-based heater control ensures stable operation, in temperatures ranging from -20 to 80°C. The compact, rugged design and waterproof connector enable use of the NTM SenseH₂® hydrogen sensor in a range of application conditions. Mating connectors can be purchased separately for ease of installation.

WARNING: The NTM SenseH₂® hydrogen sensor is not a stand alone safety device and does not provide protection from hydrogen explosion. The 1 to 4.5 V output signal, quantifying the hydrogen concentration in air, is intended to be an input to customer safety system, enabling audible alarms, system shutdown, ventilation, or other measures to ensure safe handling and use of hydrogen gas.

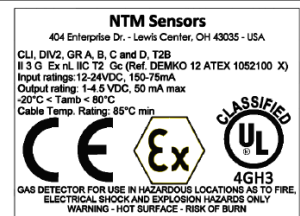

Disclaimer

The information in this sheet has been carefully reviewed and is believed to be accurate; however, no responsibility is assumed for inaccuracies. NTM Sensors reserves the right to make changes without further notice to any product, datasheet, technical data bulletin, or website. NTM Sensors is a division of NexTech Materials, Ltd.

NTM Sensors makes no warranty, representation of guarantee regarding the suitability of its product for any particular purpose, nor does NTM Sensors assume any liability arising out of the application or use of any product and specifically disclaims any and all liability, including without limitation consequential or incidental damages. "Typical" parameters can and do vary in different applications. All operating parameters, including "Typical" must be validated for each customer application by customer's technical experts.



NTM Sensors' products are not designed, intended, or authorized for use as components in systems intended for surgical implant into the body, or other application intended to support or sustain life, or for any application in which the failure of the NTM Sensors product could create a situation where personal injury or death may occur.

Should buyer purchase or use NTM Sensors' products for any such unintended or unauthorized application, Buyer shall indemnify and hold NTM Sensors and its officers, employees, subsidiaries, affiliates, and distributors harmless against all claims, costs, damages, and expenses, and reasonable attorney fees arising out of, directly or indirectly, any claim of personal injury or death associated with such unintended or unauthorized use, even if claim alleges that NTM Sensors was negligent regarding the design or manufacture of the part.

In the case of a defect in the sensor, NTM Sensors shall not be liable for any damages which may result, including, but not limited to, loss of revenue, property, or life. In any event, NTM Sensors shall limit liability to replacement of the defective unit. NTM Sensors does not convey any license under its patent rights nor the rights of others.



Table of Typical Characteristics:

Metric	Min	Max	Units
Characteristics:			
H ₂ range (in air)	0.25	4.0	%
Voltage input	12	24	Vdc
Output (sensing range)	1.0	4.5	Vdc
Error state (output signal)	0.50	0.50	Vdc
Error state (output signal)	4.75	4.75	Vdc
Power consumption (25°C)	0.10	0.15	A
Response time (T90)	—	5	Sec.
Recovery time (T10)	—	5	Sec.
Environmental Conditions:			
Ambient temperature	-20	80	°C
Relative humidity	5	95	%R.H.
Linear flow rate	0.02	5.00	m/s
Hazardous Location Approvals:	UL Class I, Div 2, GR A-D, T2B ATEX Class I, Zone 2 Ex nL IIC T2 Gc   		

Typical Calibration:

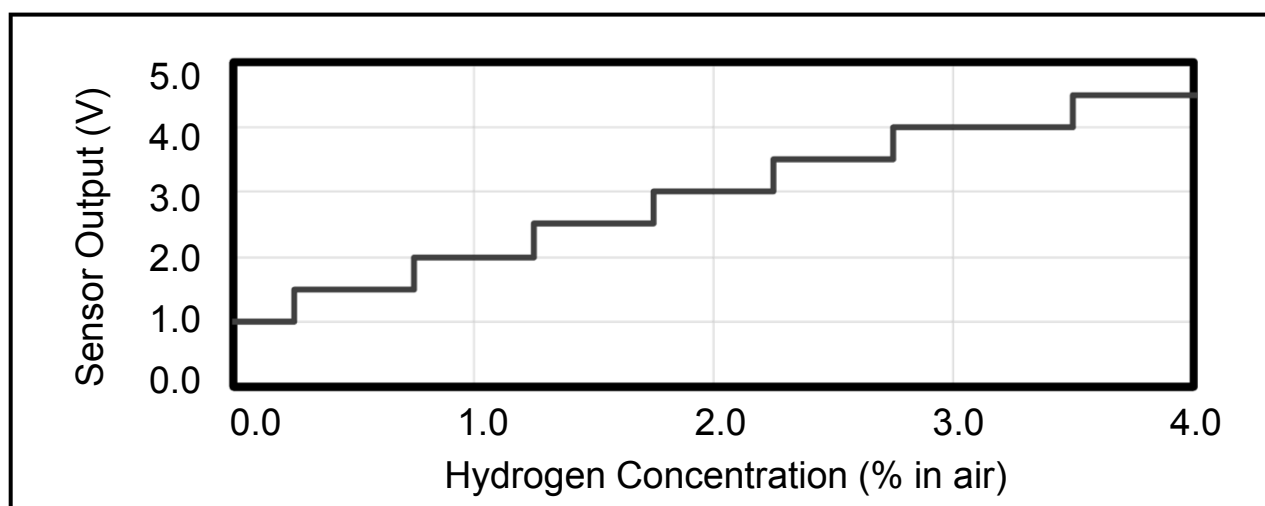

Intended Uses:

- The NTM SenseH₂® is intended for use as a hydrogen gas detector in the range of 0.25 to 4% hydrogen in air.
- Typical applications include: stationary fuel cells, fuel cell powered forklift trucks, hydrogen refueling stations, hydrogen generation (electrolyzer) systems, on-site fuel reforming systems, uninterruptible power supply (UPS) systems monitoring, telecom systems monitoring, or laboratory monitoring.

Note: Use of the NTM SenseH₂® is not validated for specific applications or environments.

It is the responsibility of system integrators to validate this component within their system for its intended use.

Operation Guidelines:

- Tampering with the sensor housing in any way can permanently damage the sensor, alter the calibration, and will void the 1 year warranty of the NTM SenseH₂® hydrogen sensor.
- The sensor should be mounted with the sensing element facing the source of the potential hydrogen source, and the sensor should be mounted in a position to minimize exposure to liquids and particulates that may obstruct diffusion of the hydrogen gas to the sensor.
- The sensor is calibrated for hydrogen detection in air. Use in oxygen concentrations other than air (21% O₂) can result in inaccurate output.
- The NTM SenseH₂® has been designed to be resistant to silicones; however, exposure to silicone-containing products, particularly if the compounds are uncured (wet), or even fully cured silicone products, may off-gas silicone vapors that may make the NTM SenseH₂® hydrogen sensor more sensitive to hydrogen over time, causing it to over-report the actual hydrogen concentration.
- Elevated levels of refrigerant gasses such as from an HVAC leak can alter the sensor's calibration and/or permanently damage the sensor. An error state is related to this phenomenon and is given in the sensor diagnostic table below.
- Exposure to 100% hydrogen and other reducing conditions can permanently damage the sensor and invalidates the warranty. An error state is related to this phenomenon and is given in the sensor diagnostic table below.

Sensor Diagnostic Outputs:

Sensor Voltage Output	Status of the sensor	Trouble Shooting
1.0V	Baseline	Normal operation in the absence of H ₂ gas above 0.5%
0.5V	Error State	<ul style="list-style-type: none"> • The power to the sensor is disconnected. • If power is intact, then the sensor has been poisoned by refrigerant gas. Please contact the manufacturer and check the area around the sensor for leaks within the HVAC system. Refrigerant gases at elevated concentrations can permanently damage the sensor. Without repairing leaks or modifying the installation area, any replacement units will eventually fail in the same way.
4.75V	Error State	<ul style="list-style-type: none"> • The sensor has been over exposed to hydrogen or a reducing atmosphere. Cycle the power. If the sensor does not return to baseline, contact the manufacturer. A reducing atmosphere can permanently reduce the sensing element and damage the sensor beyond repair.

Installation Instructions for Models 241002 and 241005

Conditions for Safe Use:

- Proper installation of the device makes operation suitable for use in Class I, Division 2, Groups A, B, C and D hazardous locations, or nonhazardous locations only.
- This device is required to be installed in accordance with Control Drawing No. 241900.
- Connector wiring should be shielded and grounded in the installation. Wire must be 20AWG or larger (>0.518mm² cross section) and have a cable temperature rating of 85°C minimum.
- Installation of a supplemental metal support bracket over the body of the sensor is required for HazLoc classification to be valid.
- These devices shall be mounted in an ATEX certified enclosure.
- These devices shall be used in an area of not more than pollution degree 2 as defined in IEC 60664-1.
- Provisions shall be made to prevent the rated voltage from being exceeded by transient disturbances of more than 40%.
- HazLoc Temperature Code Rating: T2B (UL); T2 (ATEX)
- **WARNING – Explosion Hazard – Substitution of any component may impair suitability for Class I, Division 2.**

Sensor Dimensions:

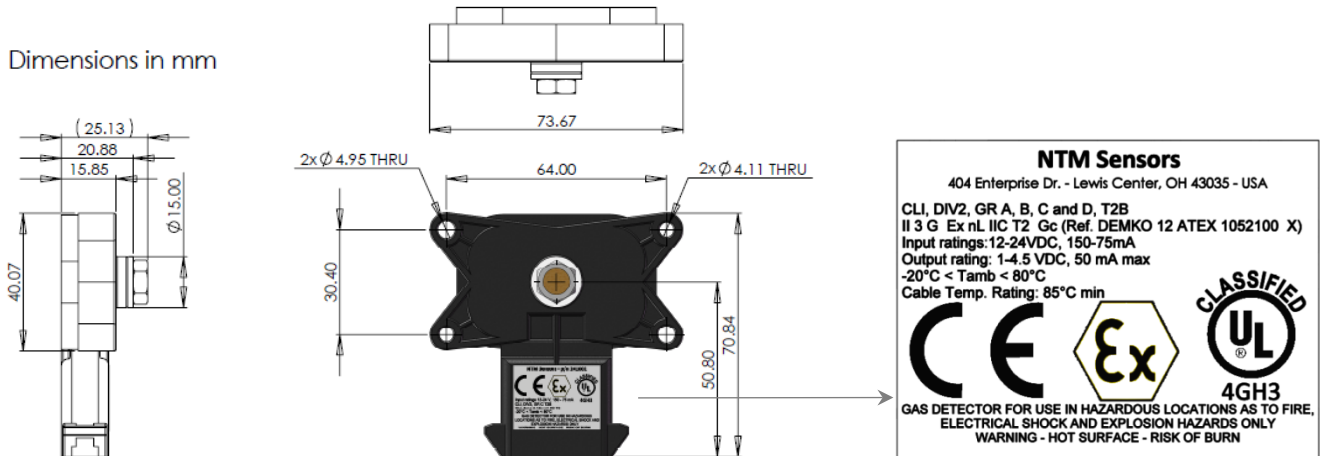

Wire Pin-Out:

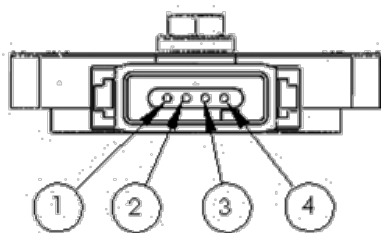

Wire Pin Out

Pin	Symbol	Function	Wire color
1	SIG+	Output Signal (+)	Blue
2	SIG-	Output Signal Ground	Black
3	PWR-	Input Power Ground	Black
4	PWR+	Input Power (+)	Red

Electrical Ratings:
Input: 12-24 VDC, 0.15 A maximum
Output: 1-4.5 VDC, 50 mA maximum



DECLARATION OF CONFORMITY

Application of Council Directive: ATEX (94/9/EC)

Standards to which Conformity is declared: EN 60079-0:2009, EN 60079-15:2005

Application of Council Directive: Electro Magnetic Compatibility (EMC) (2004/108/EC)

Standards to which Conformity is declared: EN 61326-1:2006

Manufacturer Name: NexTech Materials, LTD.

Manufacturer Address:

404 Enterprise Drive
Lewis Center, Ohio 43035 USA

Type of Equipment: Hydrogen sensor

Model Number(s): 241002, 241005

Serial Number(s) All First year of manufacture under this Technical File 2012

I, the undersigned, hereby declare that the equipment specified above conforms to the above Directives and Standards, and this Declaration is supported by a Technical File located at the Factory. Conformity Assessment is consistent with the requirements of Modules of Conformity Assessment "Module A" of the Directives.

Place
Lewis Center, Ohio USA

Signature

Steve Cummings
Sensor Group Leader
404 Enterprise Drive
Lewis Center, OH USA

Date
2/2/2012

Hazardous (Classified) Location
 Class I, Division 2, Group A, B, C and D
 Class I, Zone 2

Unclassified (Safe) Location
 Non Incendive Power Source
 (May also be in hazardous location if
 marked suitable for Div/Zone 2)

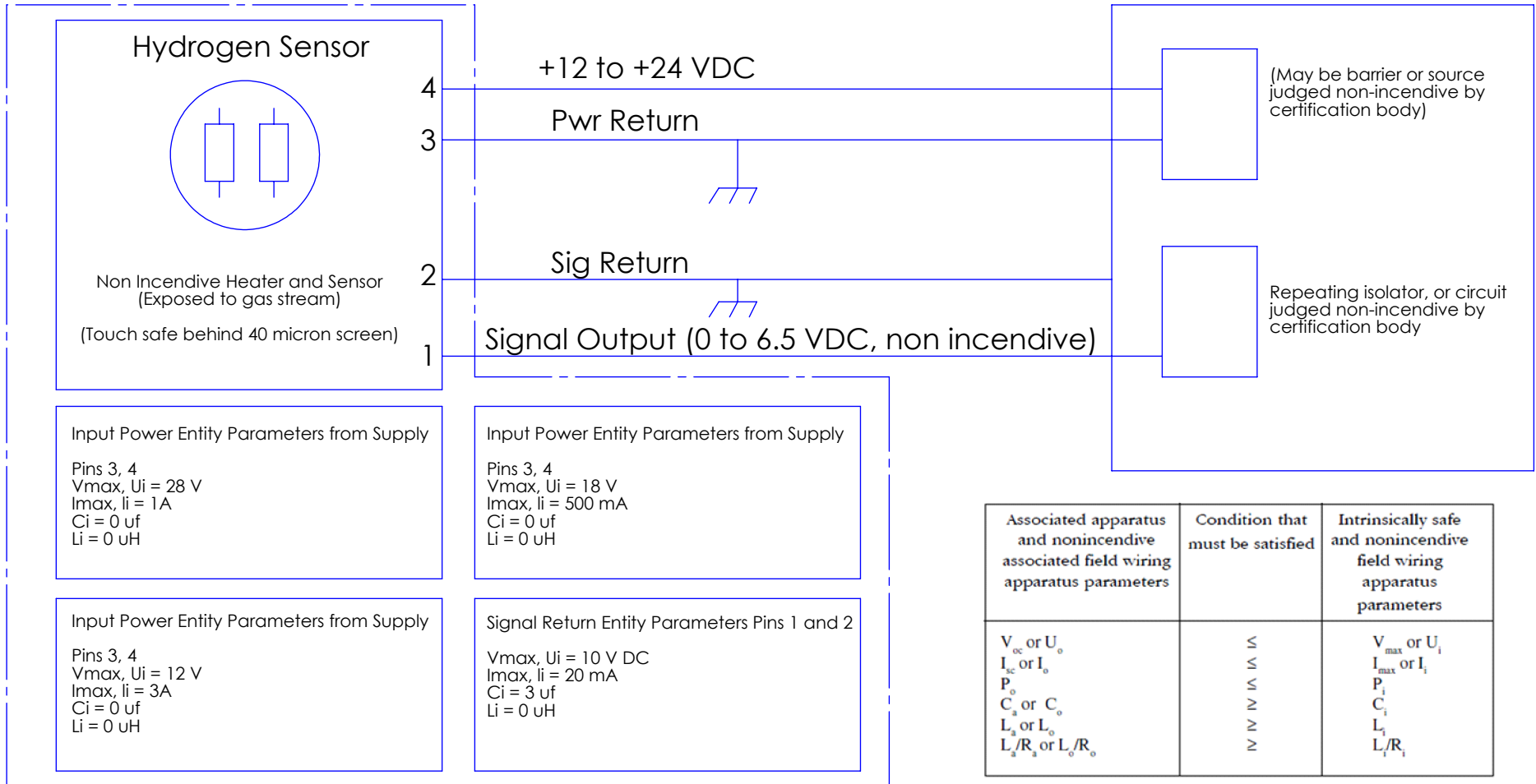

Associated apparatus and nonincendive associated field wiring apparatus parameters	Condition that must be satisfied	Intrinsically safe and nonincendive field wiring apparatus parameters
V_{oc} or U_o	\leq	V_{max} or U_i
I_{sc} or I_o	\leq	I_{max} or I_i
P_o	\leq	P_i
C_a or C_o	\geq	C_i
L_a or L_o	\geq	L_i
L_a/R_a or L_o/R_o	\geq	L_i/R_i

Notes:

1. Non Incendive Wiring Practices must be in accordance with NFPA 70 or National and Local Codes of Authority Having Jurisdiction.
2. Field Wiring must be rated at least 5 deg C higher than ambient temperature at installation site.
3. Sensor may be installed inside instrumentation system certified for Class I, Division 2 or Zone 2 location (identified by dotted lines).
4. This drawing may not be altered without notice to the Certification Body.
5. A power source judged non incendive by the Certification Body requires a 3 ampere maximum fuse.
6. Power return and signal return are connected internally in Sensor, only one wire is required.

	NAME	DATE	COMMENTS:
DRAWN	CTS	08/26/11	
CHECKED			TITLE:
ENG APPR.			NTM SenseH2 Control Drawing
MFG APPR.			DWG. NO.
Q.A.			241900

NEXTECH MATERIALS

SIZE	CHANGE REASON	REV
A		B
SCALE: 1:1	WEIGHT: g	SHEET 1 OF 1